

6FM120E-X 12V 120Ah(10hr)

The rechargeable batteries are lead-lead dioxide systems. The dilute sulfuric acid electrolyte is absorbed by separators and plates and thus immobilized. Should the battery be accidentally overcharged producing hydrogen and oxygen, special one-way valves allow the gases to escape thus avoiding excessive pressure build-up. Otherwise, the battery is completely sealed and is, therefore, maintenance-free, leak proof and usable in any position.

Battery Construction

Component	Positive plate	Negative plate	Container	Cover	Safety valve	Terminal	Separator	Electrolyte
Raw material	Lead dioxide	Lead	ABS	ABS	Rubber	Copper	Fiberglass	Sulfuric acid

General Features

- Absorbent Glass Mat (AGM) technology for efficient gas recombination of up to 99% and freedom from electrolyte maintenance or water adding.
- Not restricted for air transport-complies with IATA/ICAO Special Provision A67.
- UL-recognized component.
- Can be mounted in any orientation.
- Computer designed lead, calcium tin alloy grid for high power density.
- Long service life, float or cyclic applications.
- Maintenance-free operation.
- Low self discharge.

Dimensions and Weight

Length(mm / inch)	410 / 16.14
Width(mm / inch)	176 / 6.93
Height(mm / inch)	224 / 8.82
Total Height(mm / inch)	224 / 8.82
Approx. Weight(Kg / lbs)	33.5 / 73.9

* Weight deviation: $\pm 3\%$

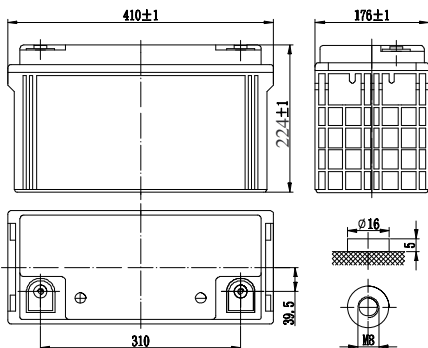

Performance Characteristics

Nominal Voltage	12V
Number of cell	6
Design Life	10 years
Nominal Capacity 77°F(25°C)	
10 hour rate (12.0A, 10.8V)	120Ah
5 hour rate (19.2A, 10.5V)	96Ah
1 hour rate (73.3A, 9.6V)	73.3Ah
Internal Resistance	
Fully Charged battery 77°F(25°C)	≤5.3mOhms
Self-Discharge	
3% of capacity declined per month at 20°C(average)	
Operating Temperature Range	
Discharge	-20~60°C
Charge	-10~60°C
Storage	-20~60°C
Max. Discharge Current 77°F(25°C)	950A(5s)
Short Circuit Current	2250A
Charge Methods: Constant Voltage Charge 77°F(25°C)	
Cycle use	2.40-2.45VPC
Maximum charging current	36A
Temperature compensation	-30mV/°C
Standby use	2.20-2.28VPC
Temperature compensation	-20mV/°C

Discharge Constant Current (Amperes at 77°F25°C)

End Point Volts/Cell	10min	15min	30min	1h	3h	5h	10h	20h
1.60V	258	209	117	73.3	29.9	20.3	12.4	6.43
1.65V	244	201	114	72.8	29.3	20.1	12.3	6.41
1.70V	231	193	110	71.3	28.7	19.7	12.2	6.38
1.75V	217	184	106	69.1	28.0	19.2	12.1	6.35
1.80V	203	177	104	67.0	27.2	18.9	12.0	6.30

Discharge Constant Power (Watts at 77°F25°C)

End Point Volts/Cell	10min	15min	30min	45min	1h	2h	3h	5h
1.60V	460	367	225	159	147	82	58.0	40.7
1.65V	437	354	218	156	145	80	57.3	40.5
1.70V	414	343	211	153	143	79	56.6	40.2
1.75V	392	331	204	149	139	77	56.0	40.0
1.80V	367	319	198	146	134	75	55.0	39.6

(Note)The above characteristics data are average values obtained within three charge/discharge cycles not the minimum values.
All data shall be changed without notice,Vision reserves the right to explain and update the information contained hereinto.

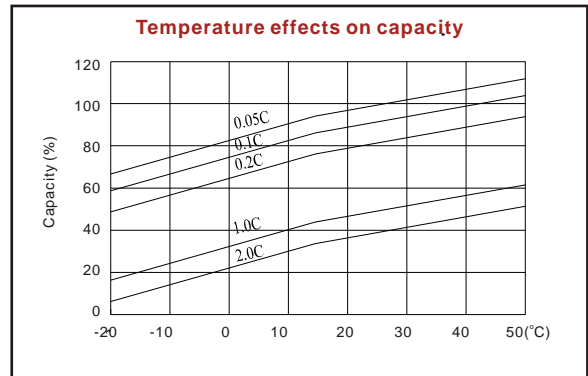
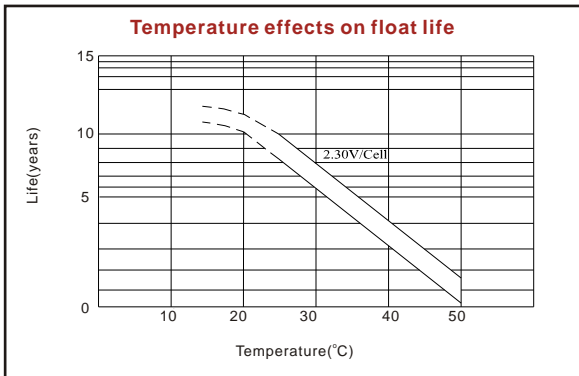
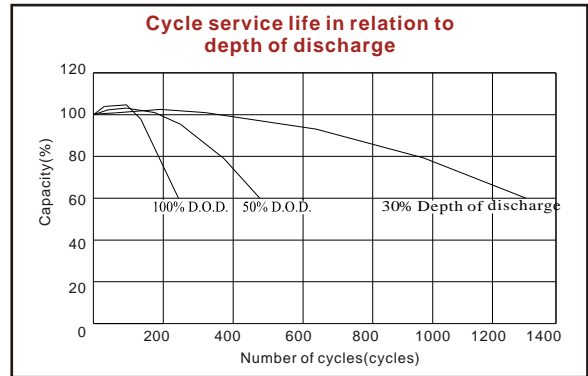
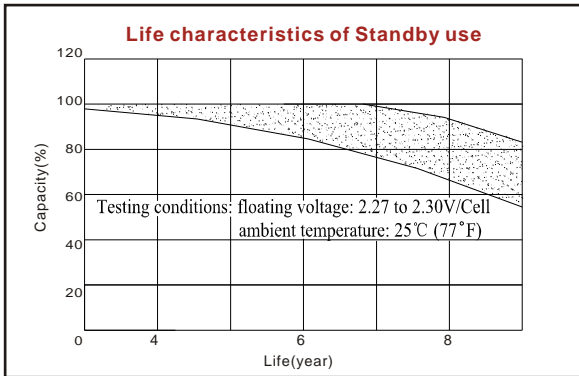
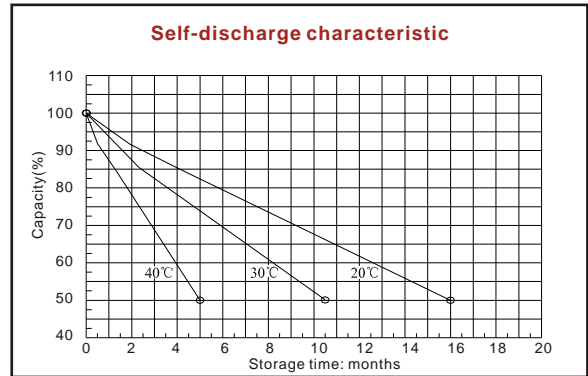
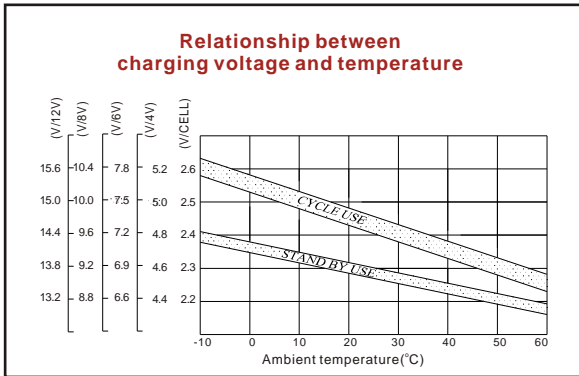
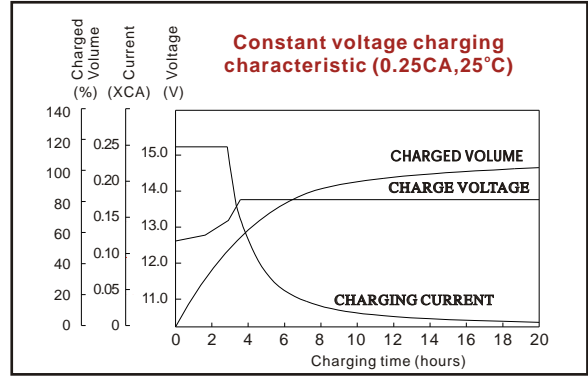
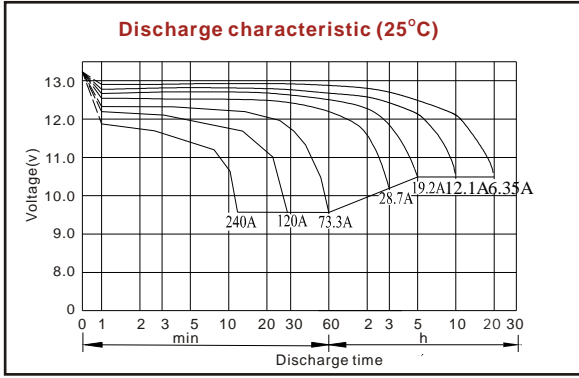

ISO9001:2008

MH25860

G4M19906-9202-E-16

www.vision-batt.com

Shenzhen Center Power Tech. Co., Ltd.
 Center Power Industrial Park, Tongfu Industrial District Dapeng Town, 518120 Shenzhen, China
 Tel: (+86-755) 8431 8088 Fax: (+86-755) 8431 8038 E-mail: sales@vision-batt.com